



MODEL NO : TM121TDSG02

MODEL VERSION: 00

SPEC VERSION : 1.0

ISSUED DATE: 2015-12-22

- Preliminary Specification
- Final Product Specification

Customer : _____

Approved by	Notes

TIANMA Confirmed :

Prepared by	Checked by	Approved by
Xianchen.Fu	Fan.Jiang	Feng.Qin

This technical specification is subjected to change without notice

The information contained herein is the exclusive property of SHANGHAI AVIC OPTOELECTRONICS Corporation, and shall not be distributed, reproduced, or disclosed in whole or in part without prior written permission of SHANGHAI AVIC OPTOELECTRONICS Corporation.



TABLE OF CONTENTS

1. OUTLINE.....	4
2. GENERAL SPECIFICATIONS.....	5
3. BLOCK DIAGRAM	6
4. DETAILED SPECIFICATIONS.....	7
5. ESTIMATED LUMINANCE LIFETIME.....	26
6. RELIABILITY TESTS	27
7. MARKINGS.....	28
8. PACKING, TRANSPORTATION AND DELIVERY.....	29
9. PRECAUTIONS	30
10. OUTLINE DRAWINGS.....	32

AVIC CONFIDENTIAL



RECORD OF REVISION

Rev	Issued Date	Description	Editor
1.0	2015-12-22	Preliminary Specification Release	Xianchen Fu

AVIC CONFIDENTIAL



1. OUTLINE

1.1 STRUCTURE AND PRINCIPLE

Color LCD module TM121TDSG02-00 is composed of the amorphous silicon thin film transistor liquid crystal display (a-Si TFT LCD) panel structure with driver LSIs for driving the TFT (Thin Film Transistor) array and a backlight.

The a-Si TFT LCD panel structure is injected liquid crystal material into a narrow gap between the TFT array glass substrate and a color-filter glass substrate.

Color (Red, Green, Blue) data signals from a host system (e.g. signal generator, etc.) are modulated into best form for active matrix system by a signal processing board, and sent to the driver LSIs which drive the individual TFT arrays.

The TFT array as an electro-optical switch regulates the amount of transmitted light from the backlight assembly, when it is controlled by data signals. Color images are created by regulating the amount of transmitted light through the TFT array of red, green and blue dots.

1.2 APPLICATION

- For industrial use

1.3 FEATURES

- High luminance
- High contrast
- Wide viewing angle
- Fast response time
- LVDS interface
- Selectable 8-bit or 6-bit digital signals for data of RGB
- Reversible-scan direction
- Built in LED driver
- Replaceable lamp for backlight



2. GENERAL SPECIFICATIONS

Display area	245.76 (H) × 184.32 (V) mm
Diagonal size of display	31cm (12.1 inches)
Drive system	a-Si TFT active matrix
Display color	16,194,277 colors (At 8-bit input, FRC terminal= High) 262,144 colors (At 6-bit input, FRC terminal= Low or Open)
Pixel	1,024 (H) × 768 (V) pixels
Pixel arrangement	BGR (Blue dot, Green dot, Red dot) vertical stripe
Dot pitch	0.080 (H) × 0.240 (V) mm
Pixel pitch	0.240 (H) × 0.240 (V) mm
Module size	279.0 (W) × 209.0 (H) × 8.6 (D) mm (typ.)
Weight	485g
Contrast ratio	700:1 (typ.)
Viewing angle	At the contrast ratio ≥ 10:1 <ul style="list-style-type: none"> • Horizontal: Right side 80° (typ.), Left side 80° (typ.) • Vertical: Up side 80° (typ.), Down side 80° (typ.)
Designed viewing direction	At DPS= Low or Open: Normal scan <ul style="list-style-type: none"> • Viewing direction without image reversal: Up side (12 o'clock) • Viewing direction with contrast peak: Down side (6 o'clock) • Viewing angle with optimum grayscale ($\gamma=2.2$): Normal axis (perpendicular) (source IC location is 12 o'clock)
Polarizer surface	Antiglare
Polarizer pencil-hardness	3H (min.) [by JIS K5600]
Color gamut	At LCD panel center 55% (typ.) [against NTSC color space]
Response time	$T_{on} + T_{off}$ (10% ← → 90%) 8ms (typ.)
Luminance	At the maximum luminance control 450cd/m ² (typ.)
Signal system	LVDS 1port
Power supply voltage	LCD panel signal processing board: 3.3V LED driver: 12.0V
Backlight	LED backlight built in LED driver
Power consumption	At the maximum luminance control, Checkered flag pattern 6.4 W (typ.)



3. BLOCK DIAGRAM

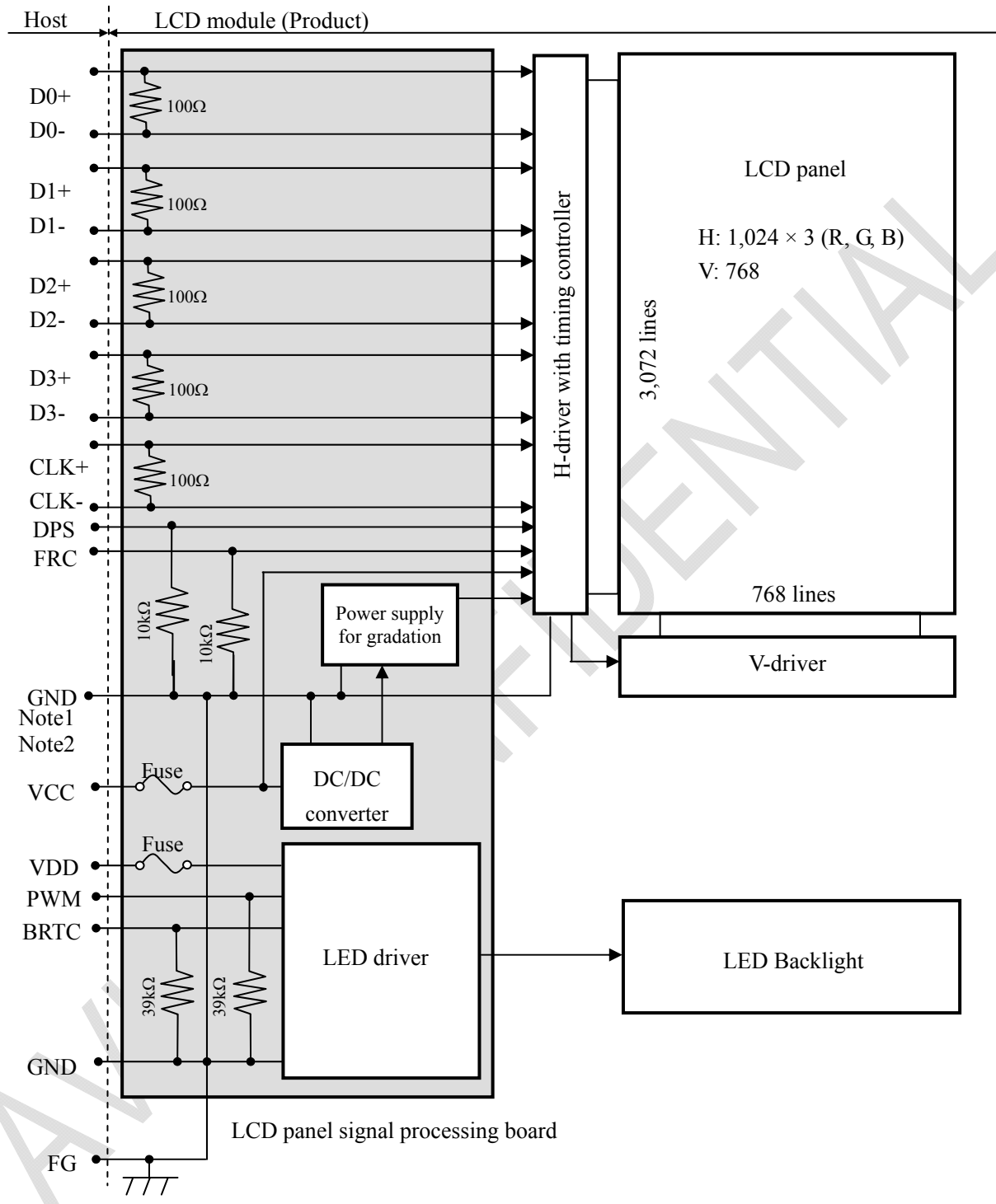

Note1: Relations between GND (Signal ground and LED driver ground) and FG (Frame ground) in the LCD module are as follows.

GND- FG	Connected
---------	-----------

Note2: GND and FG must be connected to customer equipment's ground, and it is recommended that these grounds to be connected together in customer equipment.



4. DETAILED SPECIFICATIONS

4.1 MECHANICAL SPECIFICATIONS

Parameter	Specification	Unit
Module size	279.0 ± 0.5 (W) × 209.0 ± 0.5 (H) × 8.6 ± 0.5(D)	Note1 mm
Display area	245.76 (H) × 184.32 (V)	Note1 mm
Weight	483 (typ.),	g

Note1: See "10. OUTLINE DRAWINGS".

4.2 ABSOLUTE MAXIMUM RATINGS

GND=0V

Parameter		Symbol	Rating	Unit	Remarks
Power supply voltage	LCD panel signal processing board	VCC	-0.3 to +3.96	V	
	LED driver	VDD	-0.3 to +15.0		
Input voltage for signals	Display signals Note1	VD	-0.5 to 3.96	V	
	Function signals Note2	VF	-0.5 to 3.96		
	Function signal for LED driver	PWM	-0.3 to +15.0	V	
		BRTC	-0.3 to +15.0	V	
Operating Temperature		Top	-20 to +70	°C	
Storage temperature		Tst	-30 to +80	°C	-
Relative Humidity Note3		RH	≤95	%	Ta ≤ 40°C
			≤85	%	40°C < Ta ≤ 50°C
			≤55	%	50°C < Ta ≤ 60°C
			≤36	%	60°C < Ta ≤ 70°C
			≤24	%	70°C < Ta ≤ 80°C
Absolute Humidity		AH	≤70		Ta > 70°C

Note1: D0+/-, D1+/-, D2+/-, D3+/- and CLK+/-

Note2: DPS and FRC

Note3: Ta means the ambient temperature.

It is necessary to limit the relative humidity to the specified temperature range.

Condensation on the module is not allowed.



4.3 ELECTRICAL CHARACTERISTICS

4.3.1 LCD panel signal processing board

(Ta= 25°C)

Parameter	Symbol	min.	typ.	max.	Unit	Remarks	
Power supply voltage	VCC	3.0	3.3	3.6	V	-	
Power supply current	ICC	-	340 Note1	740 Note2	mA	at VCC= 3.3V	
Permissible ripple voltage	VRP	-	-	300	mVp-p	for VCC	
Differential input threshold voltage	High	VTH	-	-	+100	mV	at VCM= 1.25V Note3
	Low	VTL	-100	-	-	mV	
Terminating resistance	RT	-	100	-	Ω	-	
Input voltage for DPS signal	High	VFH1	0.7VCC	-	VCC	V	-
	Low	VFL1	0	-	0.3VCC	V	
Input voltage for FRC signal	High	VFH2	0.7VCC	-	VCC	V	-
	Low	VFL2	0	-	0.3VCC	V	
Input current for DPS signal	High	IFH1	-	-	500	μA	-
	Low	IFL1	-500	-	-	μA	
Input current for FRC signal	High	IFH2	-	-	300	μA	-
	Low	IFL2	-300	-	-	μA	

Note1: Checkered flag pattern [by EIAJ ED-2522]

Note2: Pattern for maximum current

Note3: Common mode voltage for LVDS receiver



4.3.2 LED driver

(Ta= 25°C)

Parameter	Symbol	min.	typ.	max.	Unit	Remarks	
Power supply voltage	VDD	10.8	12.0	13.2	V	Note1	
Power supply current	IDD	-	410	480 Note2	mA	At the maximum luminance control	
Permissible ripple voltage	VRPD	-	-	200	mVp-p	for VDD Note3	
Input voltage for PWM signal	High	VDFH1	2.0	-	VDD	V	-
	Low	VDFL1	0	-	0.8	V	
Input voltage for BRTC signal	High	VDFH2	2.0	-	VDD	V	-
	Low	VDFL2	0	-	0.8	V	
PWM frequency	f _{PWM}	200	-	20k	Hz	Note4, Note5	
PWM duty ratio	DR _{PWM}	1	-	100	%	Note6, Note7	
PWM pulse width	tPWH	5	-	-	μs		

Note1: When designing of the power supply, take the measures for the prevention of surge voltage.

Note2: This value excludes peak current such as overshoot current.

Note3: The power supply lines (VDD and GND) may have ripple voltage during luminance control of LED. There is the possibility that the ripple voltage produces acoustic noise and signal wave noise in audio circuit and so on. Put a capacitor between the power supply lines (VDD and GND) to reduce the noise if necessary.

Note4: A recommended f_{PWM} value is as follows.

$$f_{\text{PWM}} = \frac{2n-1}{4} \times f_v$$

(n = integer, f_v = frame frequency of LCD module)

Note5: Depending on the frequency used, some noise may appear on the screen, please conduct a thorough evaluation.

Note6: While the BRTC signal is high, do not set the tPWH (PWM pulse width) is less than 5μs. It may cause abnormal working of the backlight. In this case, turn the backlight off and then on again by BRTC signal.

Note7: Regardless of the PWM frequency, both PWM duty ratio and PWM pulse width must be always more than the minimum values.



4.3.3 Power supply voltage ripple

This product works if the ripple voltage levels are over the permissible values as the following table, but there might be noise on the display image.

Power supply voltage		Ripple voltage (Measure at input terminal of power supply)	Note1	Unit
VCC	3.3V		≤ 300	mVp-p
VDD	12.0V		≤ 200	mVp-p

Note1: The permissible ripple voltage includes spike noise.

4.3.4 Fuse

Parameter	Fuse		Rating	Fusing current	Remarks
	Type	Supplier			
VCC	FCC16152AB	KAMAYA ELECTRIC Co., Ltd.	1.5A	3.0A	Note1
			36V		
VDD	FCC16152AB	KAMAYA ELECTRIC Co., Ltd.	1.5A	3.0A	
			36V		

Note1: The power supply's rated current must be more than the fusing current. If it is less than the fusing current, the fuse may not blow in a short time, and then nasty smell, smoke and so on may occur.



4.4 POWER SUPPLY VOLTAGE SEQUENCE

4.4.1 LCD panel signal processing board

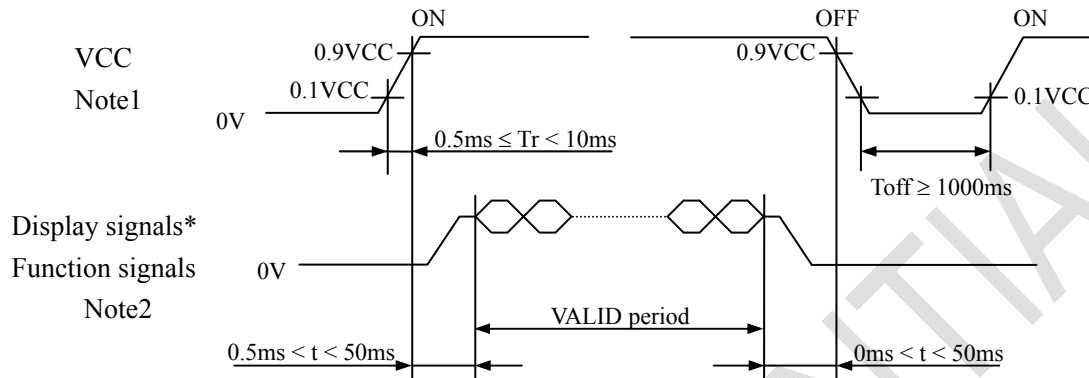

* These signals should be measured at the terminal of 100Ω resistance.

Note1: If there is a voltage variation (voltage drop) at the rising edge of VCC below 3.0V, there is a possibility that a product does not work due to a protection circuit.

Note2: Display signals (D0+/-, D1+/-, D2+/-, D3+/- and CLK+/-) and function signals (DPS and FRC) must be set to Low or High-impedance, except the VALID period (See above sequence diagram), in order to avoid the circuitry damage.

If some of display and function signals of this product are cut while this product is working, even if the signal input to it once again, it might not work normally. If a customer stops the display and function signals, VCC also must be shut down.



4.4.2 LED driver

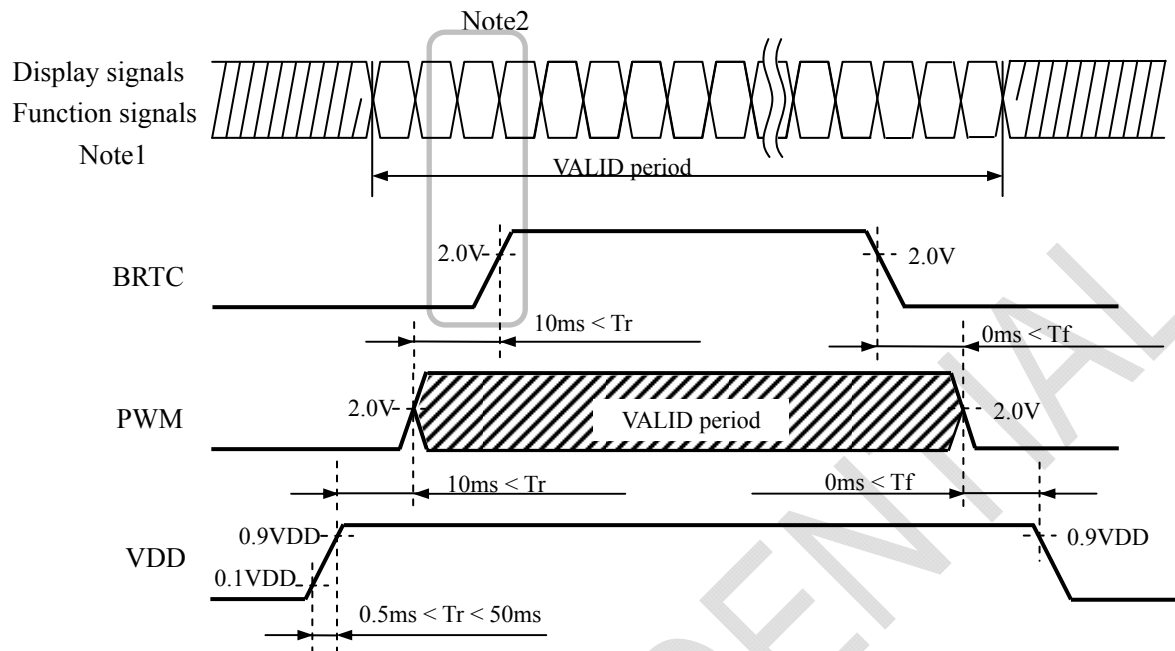

Note1: These are the display and function signals for LCD panel signal processing board.

Note2: The backlight should be turned on within the valid period of display and function signals, in order to avoid unstable data display.



4.5 CONNECTIONS AND FUNCTIONS FOR INTERFACE PINS

4.5.1 LCD panel signal processing board

CN1 socket (LCD module side): MSB240420HE (STM)

Adaptable plug: P240420 (STM) or DF14-20S-1.25C (Hirose Electric Co., Ltd. (HRS))

Pin No.	Symbol	Signal	Input data signal: 8-bit	Input data signal: 6-bit	Remarks
1	VCC	Power supply	Power supply		Note1
2	VCC				
3	GND	Ground	Ground		Note1
4	FRC	Selection of the number of colors	High	Low or Open	Note2, Note3
5	D0-	Pixel data	R0-R5, G0		Note4
6	D0+				
7	GND	Ground	Ground		Note1
8	D1-	Pixel data	G1-G5, B0-B1		Note4
9	D1+				
10	GND	Ground	Ground		Note1
11	D2-	Pixel data	B2-B5, DE		Note4
12	D2+				
13	GND	Ground	Ground		Note1
14	CLK-	Pixel clock	Pixel clock		Note4
15	CLK+				
16	GND	Ground	Ground		Note1
17	D3- / GND	Pixel data / Ground	R6-R7 G6-G7 B6-B7	Ground	Note4
18	D3+ / GND				
19	DPS	Selection of scan direction	High: Low or Open:	Reverse scan Normal scan	Note5
20	N.C.	Non connection	-		Keep this pin Open.

Note1: All GND and VCC terminals should be used without any non-connected lines.

Note2: See "4.6 DISPLAY COLORS AND INPUT DATA SIGNALS".

Note3: See "4.5.4 Connection between receiver and transmitter for LVDS".

Note4: Twist pair wires with 100Ω (Characteristic impedance) should be used between LCD panel signal processing board and LVDS transmitter.

Note5: See "4.8 SCANNING DIRECTIONS".



4.5.2 LED driver

CN2 socket (LCD module side): MSB24038P5 (STM)

Adaptable plug: P24038P5 (STM) or 51146-0500 (Molex)

Pin No.	Symbol	Signal	Remarks
1	N. C.	Non connection	Keep this pin Open.
2	PWM	Luminance control	PWM Dimming
3	BRTC	Backlight ON/OFF control	High: ON / Low: OFF
4	GND	Ground	-
5	VDD	Power supply	-

4.5.3 Positions of plug and socket

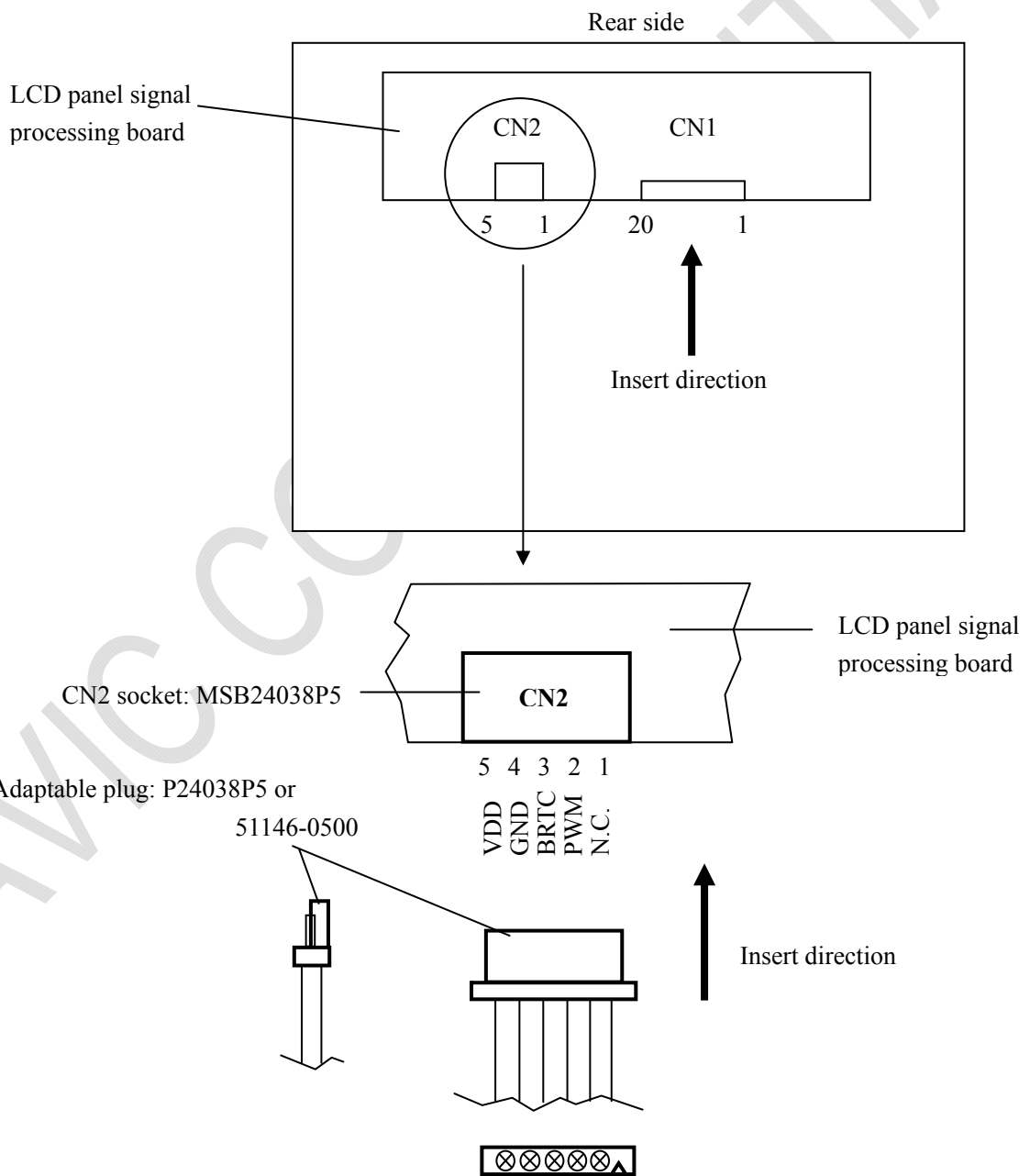



4.5.4 Connection between receiver and transmitter for LVDS

(1) Input data signal: 8-bit (FRC: High)

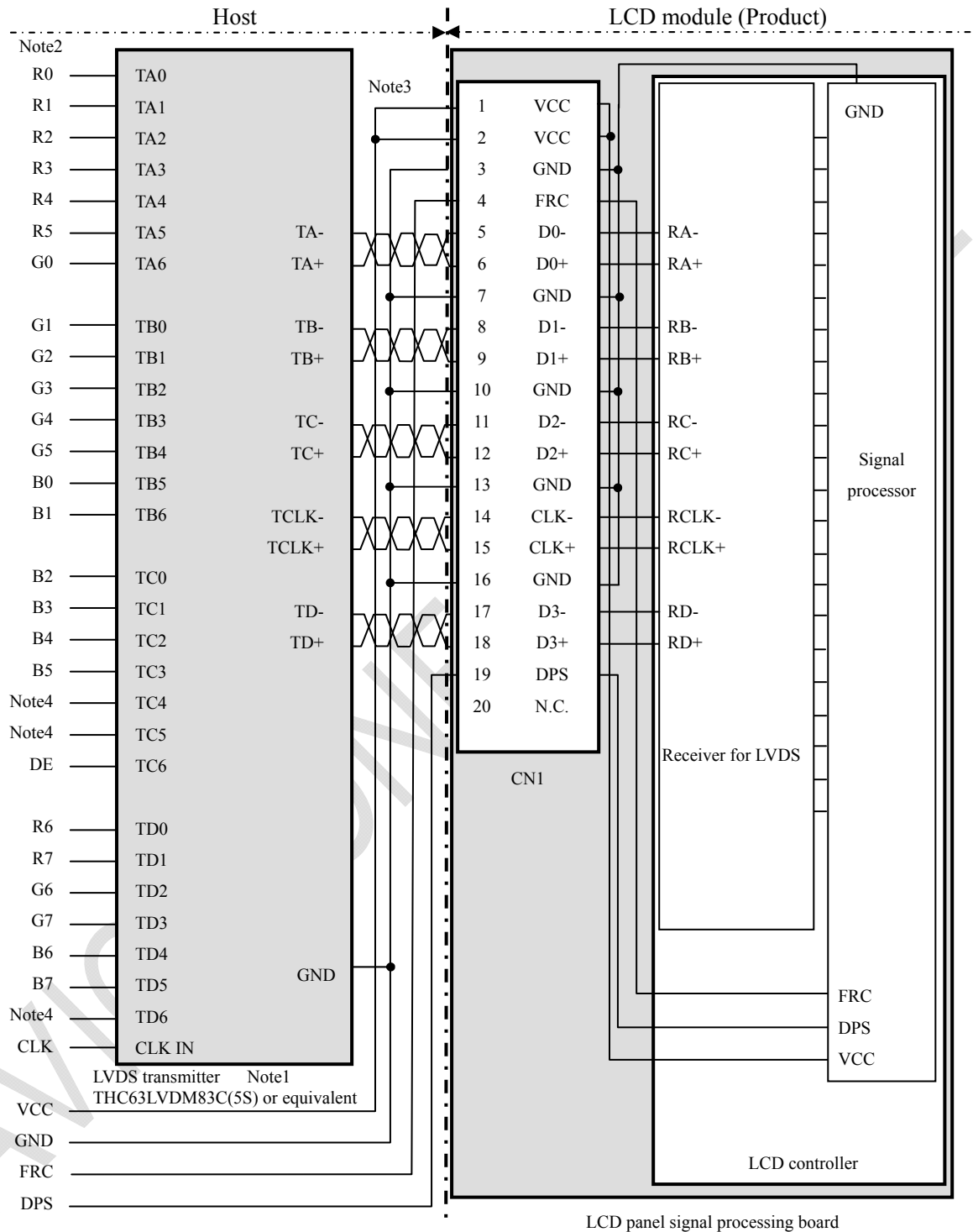

Note1: Recommended transmitter: THC63LVDM83C(5S) (THine Electronics Inc.) or equivalent.

Note2: LSB (Least Significant Bit) - R0, G0, B0 MSB (Most Significant Bit) - R7, G7, B7

Note3: Twist pair wires with 100Ω (Characteristic impedance) should be used between LCD panel signal processing board and LVDS transmitter.

Note4: Input signals to TC4, TC5 and TD6 are not used inside the product, but do not keep them open to avoid noise problem.



(2) Input data signal: 6-bit (FRC: Low or Open)

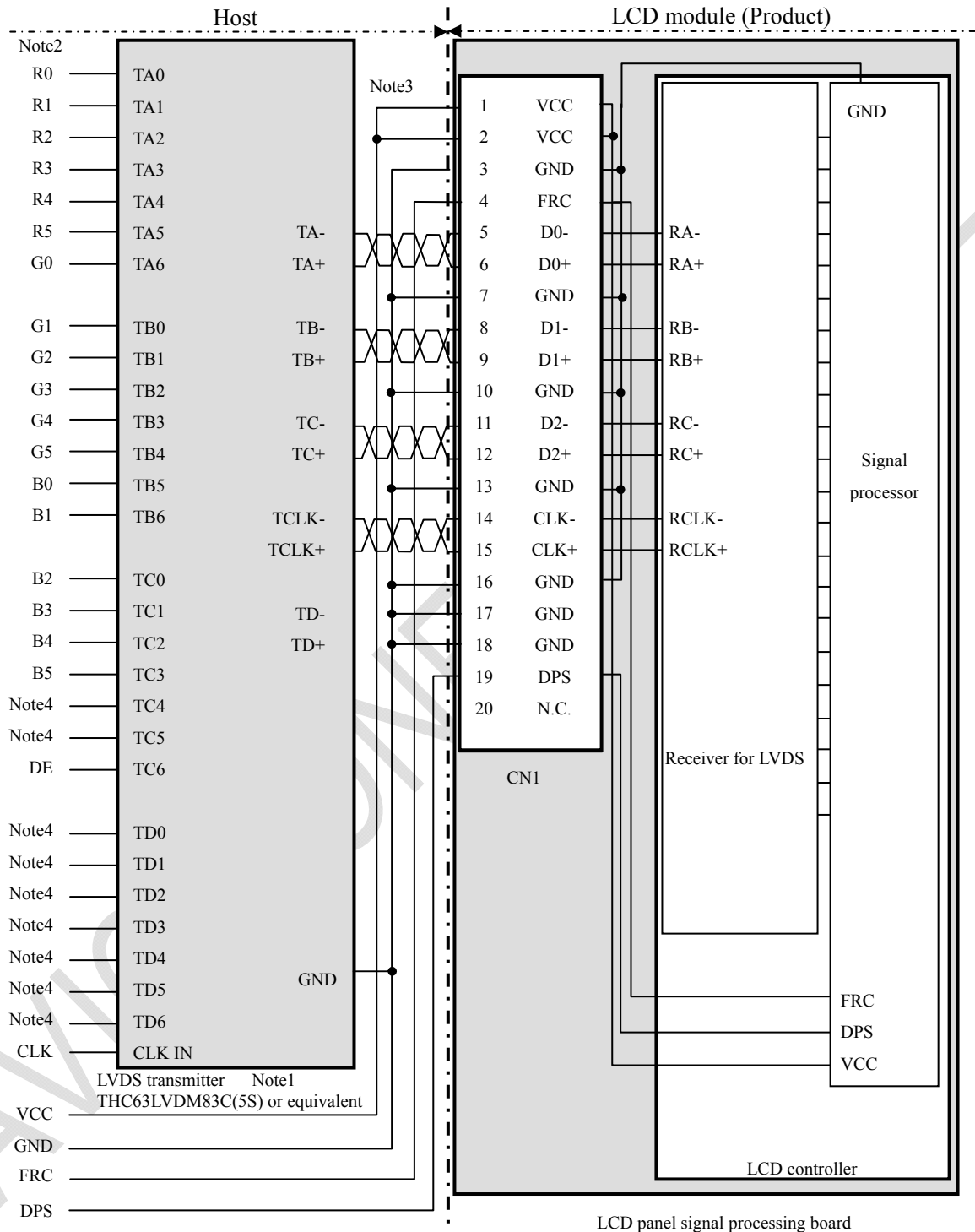

Note1: Recommended transmitter: THC63LVDM83C(5S) (THine Electronics Inc.) or equivalent.

Note2: LSB (Least Significant Bit) - R0, G0, B0 MSB (Most Significant Bit) - R5, G5, B5

Note3: Twist pair wires with 100Ω (Characteristic impedance) should be used between LCD panel signal processing board and LVDS transmitter.

Note4: Input signals to TC4, TC5 and TD0-6 are not used inside the product, but do not keep them open to avoid noise problem.



4.5.5 Input data mapping

(1) LVDS Input data signal: 8-bit

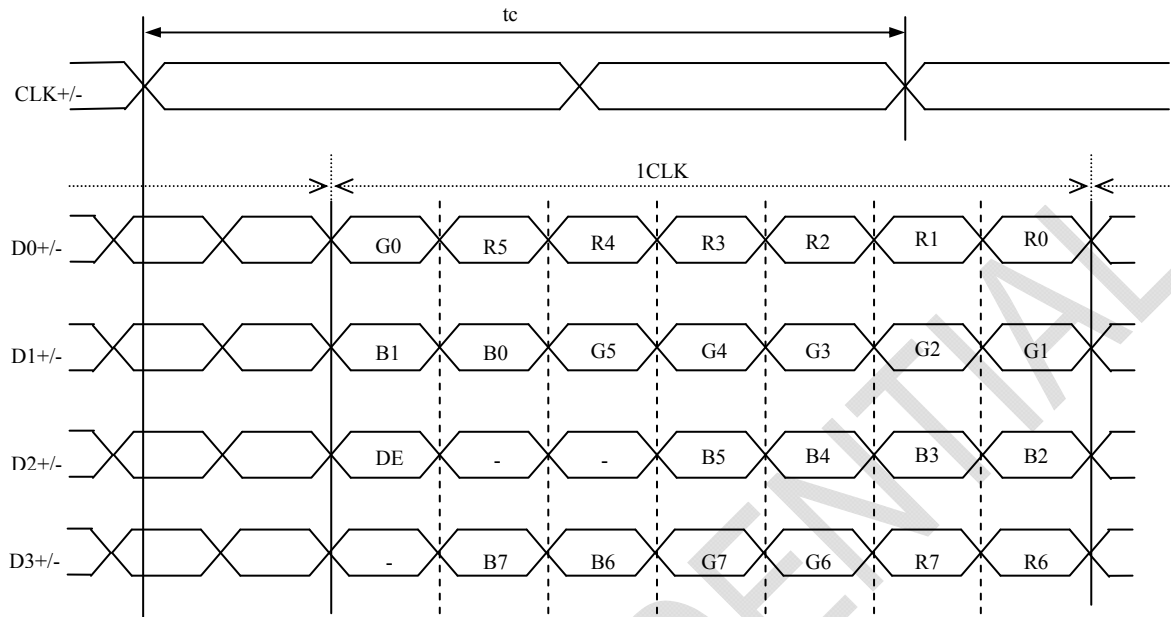

(2) LVDS Input data signal: 6-bit

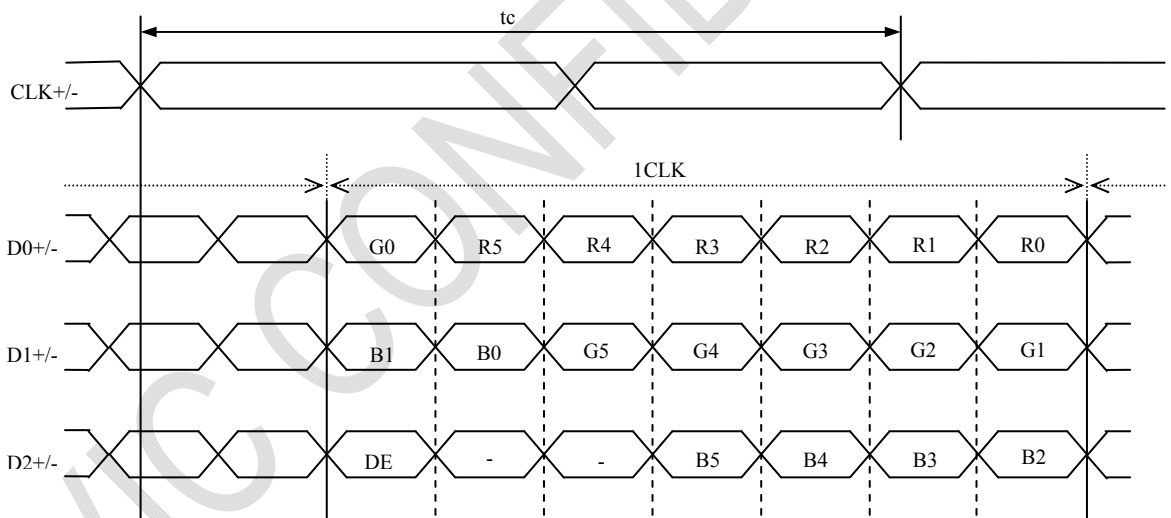

4.6 DISPLAY COLORS AND INPUT DATA SIGNALS

4.6.1 Combinations of input data signals and FRC signal

This product can display 16,194,277 colors with 253 gray scales and 262,144 colors with 64 gray scales by combination of input data signals and FRC signal. See the following table.

Combination	Input data signals	CN1- Pin No.17 and 18	FRC terminal	Display colors	Remarks
①	8-bit	D3+/-	High	16,194,277	Note1
②	6-bit	GND	Low or Open	262,144	Note2

Note1: See "4.6.2 16,194,277 colors".

Note2: See "4.6.3 262,144 colors".



4.6.2 16,194,277 colors

This product can display 16,194,277 colors with 253 gray scales by combination ①.
 (See "4.6.1 Combinations of input data signals and FRC signal".)

Also the relation between display colors and input data signals is as follows.

Display colors		Data signal (0: Low level, 1: High level)																							
		R7	R6	R5	R4	R3	R2	R1	R0	G7	G6	G5	G4	G3	G2	G1	G0	B7	B6	B5	B4	B3	B2	B1	B0
Basic Colors	Black	0	0	0	0	0	0	0	0	0	0	0	0	0	0	0	0	0	0	0	0	0	0	0	0
	Blue	0	0	0	0	0	0	0	0	0	0	0	0	0	0	0	0	1	1	1	1	1	1	1	1
	Red	1	1	1	1	1	1	1	1	0	0	0	0	0	0	0	0	0	0	0	0	0	0	0	0
	Magenta	1	1	1	1	1	1	1	1	0	0	0	0	0	0	0	0	1	1	1	1	1	1	1	1
	Green	0	0	0	0	0	0	0	0	1	1	1	1	1	1	1	1	0	0	0	0	0	0	0	0
	Cyan	0	0	0	0	0	0	0	0	1	1	1	1	1	1	1	1	1	1	1	1	1	1	1	1
	Yellow	1	1	1	1	1	1	1	1	1	1	1	1	1	1	1	1	0	0	0	0	0	0	0	0
	White	1	1	1	1	1	1	1	1	1	1	1	1	1	1	1	1	1	1	1	1	1	1	1	1
Red gray scale	Black	0	0	0	0	0	0	0	0	0	0	0	0	0	0	0	0	0	0	0	0	0	0	0	0
	dark	0	0	0	0	0	0	0	1	0	0	0	0	0	0	0	0	0	0	0	0	0	0	0	0
	↑																								
	↓																								
	bright	1	1	1	1	1	1	0	1	0	0	0	0	0	0	0	0	0	0	0	0	0	0	0	0
Red	1	1	1	1	1	1	1	0	0	0	0	0	0	0	0	0	0	0	0	0	0	0	0	0	
Green gray scale	Black	0	0	0	0	0	0	0	0	0	0	0	0	0	0	0	0	0	0	0	0	0	0	0	0
	dark	0	0	0	0	0	0	0	0	0	0	0	0	0	0	0	1	0	0	0	0	0	0	0	0
	↑																								
	↓																								
	bright	0	0	0	0	0	0	0	0	1	1	1	1	1	1	0	1	0	0	0	0	0	0	0	0
Green	0	0	0	0	0	0	0	0	1	1	1	1	1	1	1	0	0	0	0	0	0	0	0	0	
Blue gray scale	Black	0	0	0	0	0	0	0	0	0	0	0	0	0	0	0	0	0	0	0	0	0	0	0	0
	dark	0	0	0	0	0	0	0	0	0	0	0	0	0	0	0	0	0	0	0	0	0	0	0	1
	↑																								
	↓																								
	bright	0	0	0	0	0	0	0	0	0	0	0	0	0	0	0	0	1	1	1	1	1	1	0	1
Blue	0	0	0	0	0	0	0	0	0	0	0	0	0	0	0	0	1	1	1	1	1	1	1	0	



4.6.3 262,144 colors

This product can display 262,144 colors with 64 gray scales by combination ②.
 (See "4.6.1 Combinations of input data signals and FRC signal".)

Also the relation between display colors and input data signals is as follows.

Display colors		Data signal (0: Low level, 1: High level)																	
		R5	R4	R3	R2	R1	R0	G5	G4	G3	G2	G1	G0	B5	B4	B3	B2	B1	B0
Basic colors	Black	0	0	0	0	0	0	0	0	0	0	0	0	0	0	0	0	0	0
	Blue	0	0	0	0	0	0	0	0	0	0	0	0	1	1	1	1	1	1
	Red	1	1	1	1	1	1	0	0	0	0	0	0	0	0	0	0	0	0
	Magenta	1	1	1	1	1	1	0	0	0	0	0	0	1	1	1	1	1	1
	Green	0	0	0	0	0	0	1	1	1	1	1	1	0	0	0	0	0	0
	Cyan	0	0	0	0	0	0	1	1	1	1	1	1	1	1	1	1	1	1
	Yellow	1	1	1	1	1	1	1	1	1	1	1	1	0	0	0	0	0	0
	White	1	1	1	1	1	1	1	1	1	1	1	1	1	1	1	1	1	1
Red gray scale	Black	0	0	0	0	0	0	0	0	0	0	0	0	0	0	0	0	0	0
	dark	0	0	0	0	0	1	0	0	0	0	0	0	0	0	0	0	0	0
	↑																		
	↓																		
	bright	1	1	1	1	0	1	0	0	0	0	0	0	0	0	0	0	0	0
	Red	1	1	1	1	1	1	0	0	0	0	0	0	0	0	0	0	0	0
Green gray scale	Black	0	0	0	0	0	0	0	0	0	0	0	0	0	0	0	0	0	0
	dark	0	0	0	0	0	0	0	0	0	0	1	0	0	0	0	0	0	0
	↑																		
	↓																		
	bright	0	0	0	0	0	0	1	1	1	1	0	1	0	0	0	0	0	0
	Green	0	0	0	0	0	0	1	1	1	1	1	1	0	0	0	0	0	0
Blue gray scale	Black	0	0	0	0	0	0	0	0	0	0	0	0	0	0	0	0	0	0
	dark	0	0	0	0	0	0	0	0	0	0	0	0	0	0	0	0	1	0
	↑																		
	↓																		
	bright	0	0	0	0	0	0	0	0	0	0	0	0	1	1	1	1	0	1
	Blue	0	0	0	0	0	0	0	0	0	0	0	0	1	1	1	1	1	1



4.7 DISPLAY POSITIONS

The following table is the coordinates per pixel (See "4.8 SCANNING DIRECTIONS".).

C (0, 0)						
B	G	R				
C(0, 0)	C(1, 0)	...	C(X, 0)	...	C(1022, 0)	C(1023, 0)
C(0, 1)	C(1, 1)	...	C(X, 1)	...	C(1022, 1)	C(1023, 1)
•	•	•	•	•	•	•
•	•	•••	•	•••	•	•••
•	•	•	•	•	•	•
C(0, Y)	C(1, Y)	...	C(X, Y)	...	C(1022, Y)	C(1023, Y)
•	•	•	•	•	•	•
•	•	•••	•	•••	•	•
•	•	•	•	•	•	•
C(0, 766)	C(1, 766)	...	C(X, 766)	...	C(1022, 766)	C(1023, 766)
C(0, 767)	C(1, 767)	...	C(X, 767)	...	C(1022, 767)	C(1023, 767)

4.8 SCANNING DIRECTIONS

The following figures are seen from a front view.

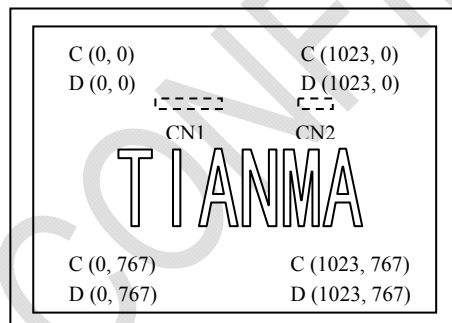

Note1

Figure1. Normal scan (DPS: Low or Open)

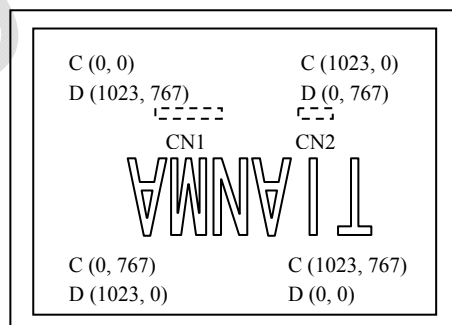

Note1

Figure2. Reverse scan (DPS: High)

Note1: Meaning of C (X, Y) and D (X, Y)

C (X, Y): The coordinates of the display position (See "4.7 DISPLAY POSITIONS".)

D (X, Y): The data number of input signal for LCD panel signal processing board



4.9 INPUT SIGNAL TIMINGS

4.9.1 Outline of input signal timings

- Horizontal signal

Note1

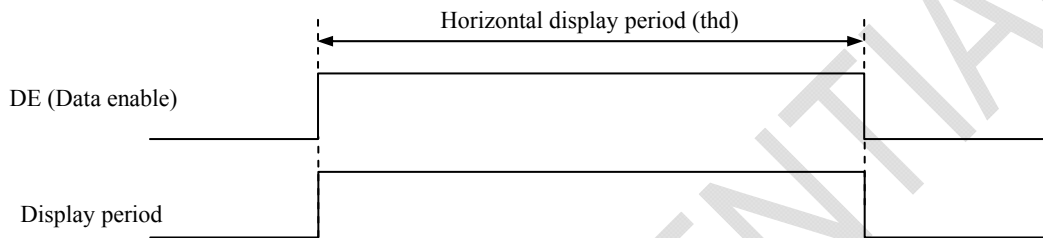

- Vertical signal

Note1

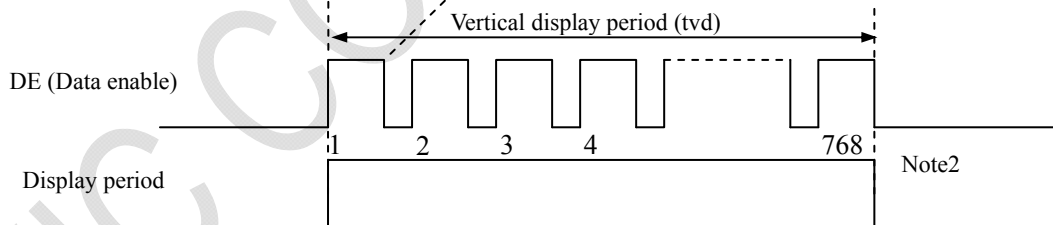

Note1: This diagram indicates virtual signal for set up to timing.

Note2: See "4.9.3 Input signal timing chart" for the pulse number.



4.9.2 Timing characteristics

(Note1, Note2, Note3)

Parameter		Symbol	min.	typ.	max.	Unit	Remarks		
CLK	Frequency	1/tc	52.0	65.0	71.0	MHz	15.385ns (typ.)		
	Duty ratio	-	-			-	-		
	Rise time, Fall time	-				ns			
DATA	CLK-DATA	Setup time	-	-			ns	-	
		Hold time	-				ns		
	Rise time, Fall time	-	ns						
DE	Horizontal	Cycle	th	16.542	20.676	26.88	μs	48.363kHz (typ.)	
				1,114	1,344	1,400	CLK		
	Vertical (One frame)	Cycle	tv	13.34	16.666	20.0	ms	60.0Hz (typ.)	
				780	806	845	H		
	CLK-DE	Setup time	-	-			ns		-
		Hold time	-				ns		
Rise time, Fall time	-	ns							

Note1: Definition of parameters is as follows.

$$tc= 1CLK, th= 1H$$

Note2: See the data sheet of LVDS transmitter.

Note3: Vertical cycle (tv) should be specified in integral multiple of Horizontal cycle (th).



4.9.3 Input signal timing chart

Horizontal timing

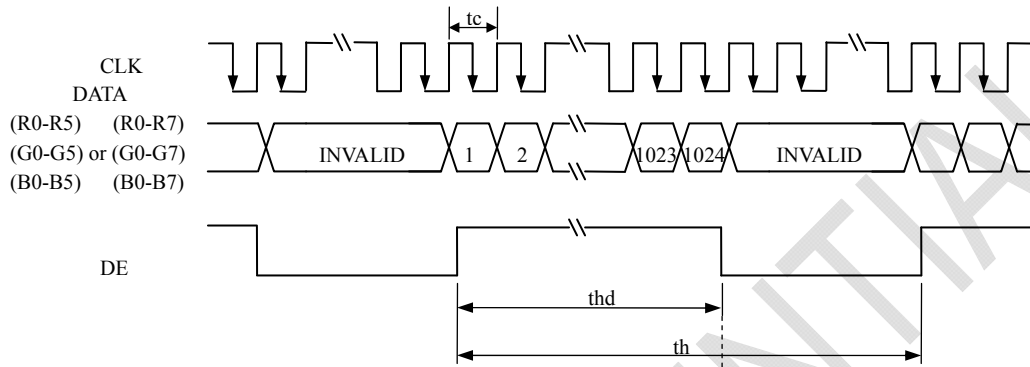

Vertical timing

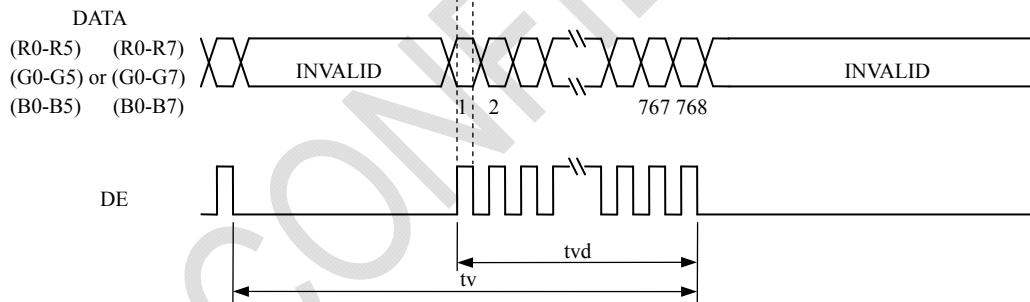



4.10 OPTICS

4.10.1 Optical characteristics

(Note1, Note2)

Parameter	Condition	Symbol	min.	typ.	max.	Unit	Measuring instrument	Remarks	
Luminance	White at center $\theta R=0^\circ, \theta L=0^\circ, \theta U=0^\circ, \theta D=0^\circ$	L	300	450	-	cd/m ²	SR-UL1R	-	
Contrast ratio	White/Black at center $\theta R=0^\circ, \theta L=0^\circ, \theta U=0^\circ, \theta D=0^\circ$	CR	500	700	-	-	SR-UL1R	Note3	
Luminance uniformity	White $\theta R=0^\circ, \theta L=0^\circ, \theta U=0^\circ, \theta D=0^\circ$	LU	-	1.25	1.33	-	SR-UL1R	Note4	
Chromaticity	White	x coordinate	Wx	0.263	0.313	0.363	-	SR-UL1R	Note5
		y coordinate	Wy	0.279	0.329	0.379	-		
	Red	x coordinate	Rx	0.529	0.579	0.629	-		
		y coordinate	Ry	0.290	0.340	0.390	-		
	Green	x coordinate	Gx	0.277	0.327	0.377	-		
		y coordinate	Gy	0.553	0.603	0.653	-		
Blue	x coordinate	Bx	0.105	0.155	0.205	-			
	y coordinate	By	0.038	0.088	0.138	-			
Color gamut	$\theta R=0^\circ, \theta L=0^\circ, \theta U=0^\circ, \theta D=0^\circ$ at center, against NTSC color space	C	48	55	-	%			
Response time	White to Black	Ton	-	3	5	ms	TRD	Note6	
	Black to White	Toff	-	5	8	ms	-100	Note7	
Viewing angle	Right	$\theta U=0^\circ, \theta D=0^\circ, CR \geq 10$	θR	70	80	-	$^\circ$	EZ Contrast	Note8
	Left	$\theta U=0^\circ, \theta D=0^\circ, CR \geq 10$	θL	70	80	-	$^\circ$		
	Up	$\theta R=0^\circ, \theta L=0^\circ, CR \geq 10$	θU	70	80	-	$^\circ$		
	Down	$\theta R=0^\circ, \theta L=0^\circ, CR \geq 10$	θD	70	80	-	$^\circ$		

Note1: These are initial characteristics.

Note2: Measurement conditions are as follows.

Ta= 25°C, VCC= 3.3V, VDD= 12.0V, PWM duty ratio: 100%,
 Display mode: XGA, Horizontal cycle= 1/48.363kHz, Vertical cycle= 1/60.0Hz,
 DPS= Low or Open: Normal scan, FRC=Low

Optical characteristics are measured at luminance saturation 20minutes after the product works in the dark room. Also measurement methods are as follows.

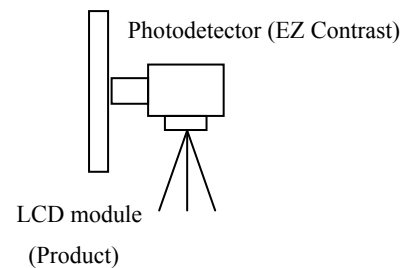
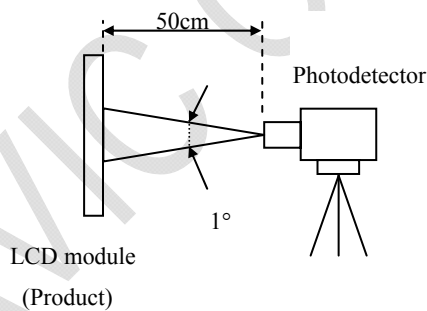

Note3: See "4.10.2 Definition of contrast ratio".

Note4: See "4.10.3 Definition of luminance uniformity".

Note5: These coordinates are found on CIE 1931 chromaticity diagram.

Note6: Product surface temperature: TopF= 29 °C

Note7: See "4.10.4 Definition of response times".

Note8: See "4.10.5 Definition of viewing angles".



4.10.2 Definition of contrast ratio

The contrast ratio is calculated by using the following formula.

Contrast ratio (CR) = Luminance of white screen / Luminance of black screen

4.10.3 Definition of luminance uniformity

The luminance uniformity is calculated by using following formula.

Luminance uniformity (LU) = Maximum luminance from 1 to 9 / Minimum luminance from 1 to 9

The luminance is measured at near the 9 points shown below.

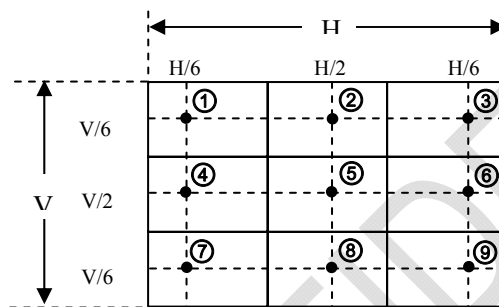

4.10.4 Definition of response times

Response time is measured at the time when the luminance changes from "white" to "black", or "black" to "white" on the same screen point, by photo-detector. Ton is the time when the luminance changes from 90% down to 10%. Also Toff is the time when the luminance changes from 10% up to 90% (See the following diagram.).

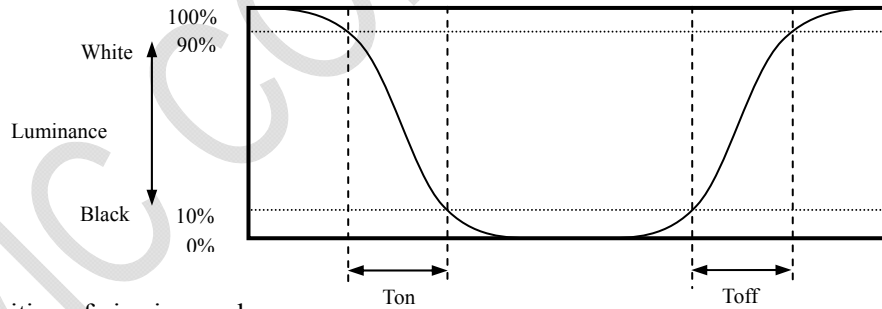

4.10.5 Definition of viewing angles

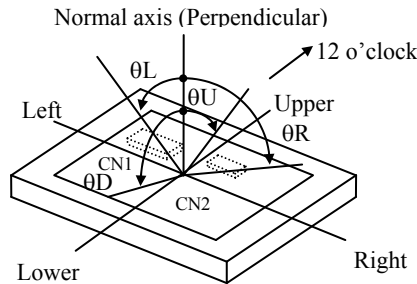



5. ESTIMATED LUMINANCE LIFETIME

The luminance lifetime is the time from initial luminance to half-luminance.

This lifetime is the estimated value, and is not guarantee value.

Condition		Estimated luminance lifetime (Life time expectancy) Note1	Unit
LED lifetime	25°C (Ambient temperature of the product) Continuous operation, PWM duty ratio: 100%	50,000	H

Note1: Optical performance should be evaluated at Ta=25°C only If LED is driven by high current, high ambient temperature & humidity condition. The life time of LED will be reduced. Operating life means brightness goes down to 50% initial brightness. Typical operating life time is estimated data.

AVIC CONFIDENTIAL



6. RELIABILITY TESTS

No	Test Item	Condition	Remarks
1	High Temperature Operation	Ts = +70°C, 240 hours (Note1)	IEC60068-2-1:2007 GB2423.2-2008
2	Low Temperature Operation	Ta = -20°C, 240 hours (Note1)	IEC60068-2-1:2007 GB2423.1-2008
3	High Temperature Storage	Ta = +80°C, 240 hours	IEC60068-2-1:2007 GB2423.2-2008
4	Low Temperature Storage	Ta = -30°C, 240 hours	IEC60068-2-1:2007 GB2423.1-2008
5	Storage at High Temperature and Humidity	Ta = +50°C, 80% RH max, 240hours	IEC60068-2-78 :2001 GB/T2423.3—2006
6	Thermal Shock (non-operation)	-20°C 30 min ~ +60°C 30 min, Change time:5min, 20 Cycle	Start with cold temperature, End with high temperature, IEC60068-2-14:1984, GB2423.22-2002
7	ESD(Operation)	C=150pF, R=330Ω, Air: ±15Kv, 9points,25times/point; Contact: ±8Kv, 9points,25times/point (Environment: 15°C~35°C, 30%~60%. 86Kpa~106Kpa)	IEC61000-4-2:2001 GB/T17626.2-2006
8	Package Drop Test	Height: 60cm, 1corner, 3edges, 6surfaces	IEC60068-2-32:1990 GB/T2423.8—1995
9	Vibration (Non-operation)	Frequency range:5~100Hz,11.76m/s ² 1minute/cycle X,Y,Z directions 50times each directions	IEC60068-2-6:1982 GB2423.10-1995
10	Shock (Non-operation)	30G,11ms, ±X,Y,Z directions,3times For each direction	IEC60068-2-27:1987 GB/T2423.5—1995

Note1: Ts is the temperature of panel's surface.

Note2: Ta is the ambient temperature of sample.

Note3: Before cosmetic and function test, the product must have enough recovery time, at least 2 hours at room temperature.

Note 4: In the standard condition, there shall be no practical problem that may affect the display function. After the reliability test, the product only guarantees operation, but don't guarantee all of the cosmetic specification.



7. MARKINGS

The various markings are attached to this product. See "**10. OUTLINE DRAWINGS**" for attachment positions.

7.1 NAMEPLATE LABEL

TBD

7.2 BARCODE LABEL

TBD

AVIC CONFIDENTIAL



8. PACKING, TRANSPORTATION AND DELIVERY

AVIC will pack products to deliver to customer in accordance with AVIC's packing specifications, and will deliver products to customer in such a condition that products will not suffer from damage during transportation. The delivery conditions are as follows.

8.1 INNER PACKING BOX

10 products are packed as the maximum in an inner packing box (See "**8.6 OUTLINE FIGURE FOR PACKING**"). The type name and quantity are shown on outside of the inner packing box, either labeling or printing. In case the inner packing box with products is dropped from a height of 60cm or more, there is a risk of damage to products.

8.2 OUTER PACKING BOX

The inner box with products is packed in an outer packing box (See "**8.6 OUTLINE FIGURE FOR PACKING**"). The type name and quantity are shown on outside of the outer packing box, either labeling or printing. In case the outer packing box with products is dropped from a height of 60cm or more, there is a risk of damage to products.

8.3 INSPECTION RECORD SHEET

Inspection record sheets are included in an inner packing box with products. It is summarized to a number of products for pass/fail assessment.

8.4 TRANSPORTATION

The product is transported by vehicle and aircraft.

8.5 SIZE AND WEIGHT FOR PACKING BOXES

TBD

8.6 OUTLINE FIGURE FOR PACKING

TBD



9. PRECAUTIONS

9.1 MEANING OF CAUTION SIGNS

The following caution signs have very important meaning. **Be sure to read "9.2 CAUTIONS" and "9.3 ATTENTIONS"!**



This sign has the meaning that a customer will be injured or the product will sustain damage if the customer practices wrong operations.



This sign has the meaning that a customer will be injured if the customer practices wrong operations.

9.2 CAUTIONS



*** Do not shock and press the LCD panel and the backlight! There is a danger of breaking, because they are made of glass. (Shock: Equal to or no greater than 539m/s^2 and equal to or no greater than 11ms, Pressure: Equal to or no greater than 19.6 N ($\phi 16\text{mm}$ jig))**

9.3 ATTENTIONS



9.3.1 Handling of the product

- ① Take hold of both ends without touching the circuit board when the product (LCD module) is picked up from inner packing box to avoid broken down or misadjustment, because of stress to mounting parts on the circuit board.
- ② When the product is put on the table temporarily, display surface must be placed downward.
- ③ When handling the product, take the measures of electrostatic discharge with such as earth band, ionic shower and so on, because the product may be damaged by electrostatic.
- ④ The torque for product mounting screws must never exceed 0.392N·m. Higher torque might result in distortion of the bezel.
- ⑤ The product must be installed using mounting holes without undue stress such as bends or twist (See outline drawings). And do not add undue stress to any portion (such as bezel flat area). Bends or twist described above and undue stress to any portion may cause display mura.
- ⑥ Do not press or rub on the sensitive product surface. When cleaning the product surface, wipe it a soft dry cloth.
- ⑦ Do not push or pull the interface connectors while the product is working.
- ⑧ When handling the product, use of an original protection sheet on the product surface (polarizer) is recommended for protection of product surface. Adhesive type protection sheet may change color or characteristics of the polarizer.
- ⑨ Usually liquid crystals don't leak through the breakage of glasses because of the surface tension of thin layer and the construction of LCD panel. But, if you contact with liquid crystal by any chance, please wash it away with soap and water.



9.3.2 Environment

- ① Do not operate or store in high temperature, high humidity, dewdrop atmosphere or corrosive gases. Keep the product in packing box with antistatic pouch in room temperature to avoid dusts and sunlight, when storing the product.
- ② In order to prevent dew condensation occurred by temperature difference, the product packing box must be opened after enough time being left under the environment of an unpacking room. Evaluate the storage time sufficiently because dew condensation is affected by the environmental temperature and humidity. (Recommended leaving time: 6 hours or more with the original packing state after a customer receives the package)
- ③ Do not operate in high magnetic field. If not, circuit boards may be broken.
- ④ This product is not designed as radiation hardened.

9.3.3 Characteristics

The following items are neither defects nor failures.

- ① Characteristics of the LCD (such as response time, luminance, color uniformity and so on) may be changed depending on ambient temperature. If the product is stored under condition of low temperature for a long time, it may cause display mura. In this case, the product should be operated after enough time being left under condition of operating temperature.
- ② Display mura, flickering, vertical streams or tiny spots may be observed depending on display patterns.
- ③ Do not display the fixed pattern for a long time because it may cause image sticking. Use a screen saver, if the fixed pattern is displayed on the screen.
- ④ The display color may be changed depending on viewing angle because of the use of condenser sheet in the backlight.
- ⑤ Optical characteristics may be changed depending on input signal timings.

9.3.4 Others

- ① All GND, VCC and VDD terminals should be used without any non-connected lines.
- ② Do not disassemble a product or adjust variable resistors.
- ③ See "REPLACEMENT MANUAL FOR LAMP HOLDER SET", when replacing lamp holder set.
- ④ Pack the product with the original shipping package, in order to avoid any damages during transportation, when returning the product to AVIC.



10. OUTLINE DRAWINGS

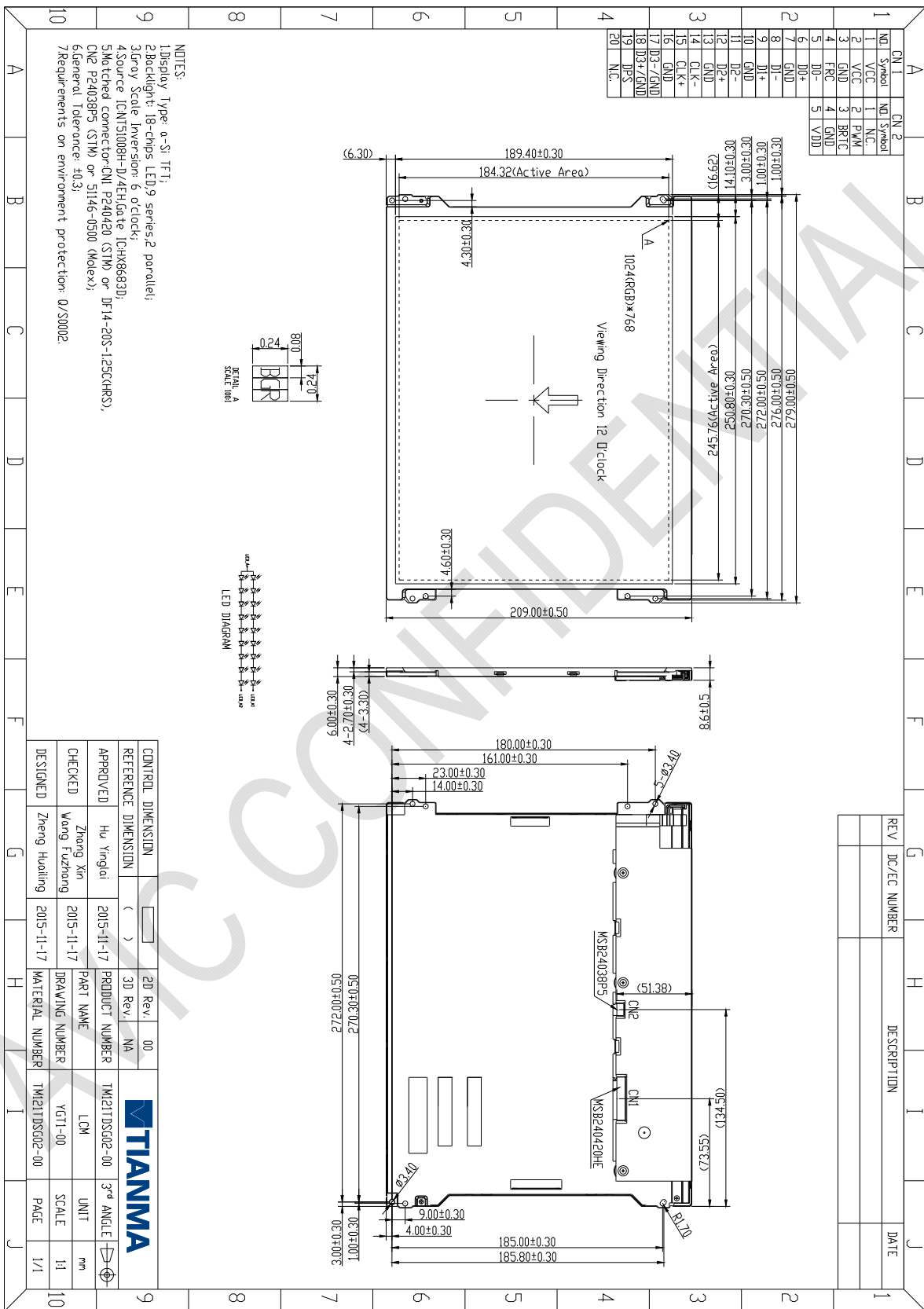

The information contained herein is the exclusive property of SHANGHAI AVIC OPTOELECTRONICS Corporation, and shall not be distributed, reproduced, or disclosed in whole or in part without prior written permission of SHANGHAI AVIC OPTOELECTRONICS Corporation.